

# DMP 331

## Industrial Pressure Transmitter for Low Pressure

Stainless Steel Sensor

accuracy according to IEC 60770:  
standard: 0.35 % FSO  
option: 0.25 / 0.1 % FSO



### Nominal pressure

from 0 ... 100 mbar up to 0 ... 60 bar

### Output signals

2-wire: 4 ... 20 mA

3-wire: 0 ... 20 mA / 0 ... 10 V

others on request

### Special characteristic

- ▶ perfect thermal behaviour
- ▶ excellent long term stability
- ▶ pressure port  
G 1/2" flush from 100 mbar



### Optional versions

- ▶ IS-version  
Ex ia = intrinsically safe  
for gases and dusts
- ▶ SIL 2-according to  
IEC 61508 / IEC 61511
- ▶ welded pressure sensor
- ▶ customer specific versions

The pressure transmitter DMP 331 can be used in all industrial areas when the medium is compatible with stainless steel 1.4404 (316 L) or 1.4435 (316 L). Additional are different elastomer seals as well as a helium tested welded version available.

The modulare concept of the device allows to combine different stainless steel sensors and electronic modules with a variety of electrical and mechanical versions. Thus a diversity of variations is created, meeting almost all requirements in industrial applications.

### Preferred areas of use are

-  Plant and machine engineering
-  Environmental engineering  
(water - sewage - recycling)
-  Energy industry



Input pressure range									
Nominal pressure gauge	[bar]	-1...0	0.10	0.16	0.25	0.40	0.60	1	1.6
Nominal pressure abs.	[bar]	-	-	-	-	0.40	0.60	1	1.6
Overpressure	[bar]	5	0.5	1	1	2	5	5	10
Burst pressure $\geq$	[bar]	7.5	1.5	1.5	1.5	3	7.5	7.5	15
Nominal pressure gauge / abs.	[bar]	2.5	4	6	10	16	25	40	60
Overpressure	[bar]	10	20	40	40	80	80	105	105
Burst pressure $\geq$	[bar]	15	25	50	50	120	120	210	210
Vacuum resistance		$P_N \geq 1$ bar: unlimited vacuum resistance $P_N < 1$ bar: on request							
Output signal / Supply									
Standard		2-wire: 4 ... 20 mA / $V_S = 8 \dots 32 V_{DC}$		SIL-version: $V_S = 14 \dots 28 V_{DC}$					
Option IS-protection		2-wire: 4 ... 20 mA / $V_S = 10 \dots 28 V_{DC}$		SIL-version: $V_S = 14 \dots 28 V_{DC}$					
Options 3-wire		3-wire: 0 ... 20 mA / $V_S = 14 \dots 30 V_{DC}$							
		0 ... 10 V / $V_S = 14 \dots 30 V_{DC}$							
Performance									
Accuracy <sup>1</sup>		standard: nominal pressure $< 0.4$ bar: $\leq \pm 0.5$ % FSO nominal pressure $\geq 0.4$ bar: $\leq \pm 0.35$ % FSO option 1: nominal pressure $\geq 0.4$ bar: $\leq \pm 0.25$ % FSO option 2: for all nominal pressure: $\leq \pm 0.1$ % FSO							
Permissible load		current 2-wire: $R_{max} = [(V_S - V_{S min}) / 0.02 A] \Omega$ current 3-wire: $R_{max} = 240 \Omega$ voltage 3-wire: $R_{min} = 10 k\Omega$							
Influence effects		supply: 0.05 % FSO / 10 V				load: 0.05 % FSO / k $\Omega$			
Long term stability		$\leq \pm 0.1$ % FSO / year at reference conditions							
Response time		2-wire: $\leq 10$ msec				3-wire: $\leq 3$ msec			
<sup>1</sup> accuracy according to IEC 60770 – limit point adjustment (non-linearity, hysteresis, repeatability)									
Thermal effects (Offset and Span)									
Nominal pressure $P_N$	[bar]	-1 ... 0			< 0.40			$\geq 0.40$	
Tolerance band	[% FSO]	$\leq \pm 0.75$			$\leq \pm 1$			$\leq \pm 0.75$	
in compensated range	[°C]	-20 ... 85			0 ... 70			-20 ... 85	
Permissible temperatures									
Permissible temperatures		medium: -40 ... 125 °C electronics / environment: -40 ... 85 °C storage: -40 ... 100 °C							
Electrical protection									
Short-circuit protection		permanent							
Reverse polarity protection		no damage, but also no function							
Electromagnetic compatibility		emission and immunity according to EN 61326							
Mechanical stability									
Vibration		10 g RMS (25 ... 2000 Hz) according to DIN EN 60068-2-6							
Shock		500 g / 1 msec according to DIN EN 60068-2-27							
Materials									
Pressure port		stainless steel 1.4404 (316 L)							
Housing		stainless steel 1.4404 (316 L)							
Option compact field housing		stainless steel 1.4305 (303), cable gland brass, nickel plated						others on request	
Seals (media wetted)		standard: FKM options: EPDM welded version <sup>2</sup> (for $P_N \leq 40$ bar)						others on request	
Diaphragm		stainless steel 1.4435 (316 L)							
Media wetted parts		pressure port, seals, diaphragm							
<sup>2</sup> welded version only with pressure ports according to EN 837, $P_N \leq 40$ bar									
Explosion protection (only for 4 ... 20 mA / 2-wire)									
Approvals DX19-DMP 331		IBExU 10 ATEX 1068 X / IECEx IBE 12.0027X zone 0: II 1G Ex ia IIC T4 Ga zone 20: II 1D Ex ia IIIC T 85°C Da							
Safety technical maximum values		$U_i = 28$ V, $I_i = 93$ mA, $P_i = 660$ mW, $C_i \approx 0$ nF, $L_i \approx 0$ $\mu$ H, the supply connections have an inner capacity of max. 27 nF to the housing							
Permissible temperatures for environment		in zone 0: -20 ... 60 °C with $p_{atm}$ 0.8 bar up to 1.1 bar in zone 1 or higher: -20 ... 70 °C							
Connecting cables (by factory)		cable capacitance: signal line/shield also signal line/signal line: 160 pF/m cable inductance: signal line/shield also signal line/signal line: 1 $\mu$ H/m							

Miscellaneous	
Option SIL2 version <sup>3</sup>	according to IEC 61508 / IEC 61511
Current consumption	signal output current: max. 25 mA signal output voltage: max. 7 mA
Weight	approx. 200 g
Installation position	any <sup>4</sup>
Operational life	100 million load cycles
CE-conformity	EMC Directive: 2014/30/EU
ATEX Directive	2014/34/EU

<sup>3</sup> only for 4 ... 20 mA / 2-wire, not in combination with accuracy 0.1 %

<sup>4</sup> Pressure transmitters are calibrated in a vertical position with the pressure connection down. If this position is changed on installation there can be slight deviations in the zero point for pressure ranges  $P_N \leq 1$  bar.

### Wiring diagrams

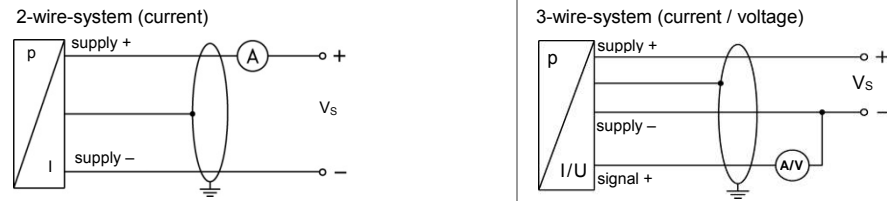

### Pin configuration

Electrical connection	ISO 4400	Binder 723 (5-pin)	M12x1/metal (4-pin)	Bayonet MIL-C-26482 (10-6)		field housing	cable colours (IEC 60757)
				2-wire	3-wire		
Supply +	1	3	1	A	A	IN +	wh (white)
Supply -	2	4	2	B	D	IN -	bn (brown)
Signal + (for 3-wire)	3	1	3	-	B	OUT +	gn (green)
Shield	ground pin	5	4	pressure port		⊥	gnye (green-yellow)

### Electrical connections (dimensions in mm)

#### standard

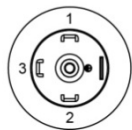
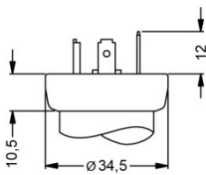

ISO 4400 (IP 65)

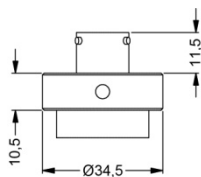

Bayonet MIL-C-26482 (10-6) (IP 67)

#### option

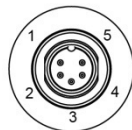
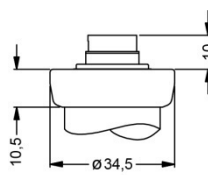

Binder Series 723 5-pin (IP 67)

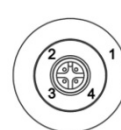
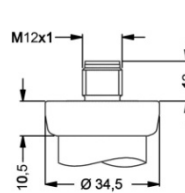

M12x1 4-pin (IP 67)

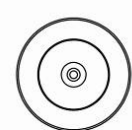
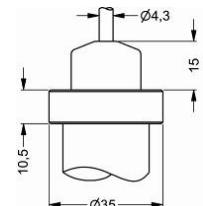

cable outlet with PVC cable (IP 67)<sup>5</sup>

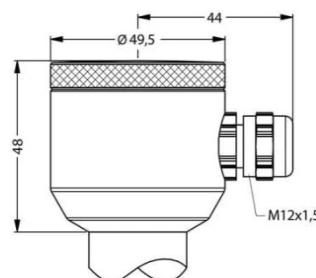

compact field housing (IP 67)

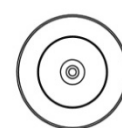
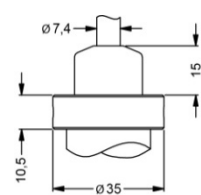

cable outlet, cable with ventilation tube (IP 68)<sup>6</sup>

⇒ universal field housing stainless steel 1.4404 (316 L) with cable gland M20x1.5 (ordering code 880) and other versions on request

<sup>5</sup> standard: 2 m PVC cable without ventilation tube (permissible temperature: -5 ... 70°C)

<sup>6</sup> different cable types and lengths available, permissible temperature depends on kind of cable

# DMP 331

Industrial Pressure Transmitter

Technical Data

## Mechanical connections (dimensions in mm)

### standard

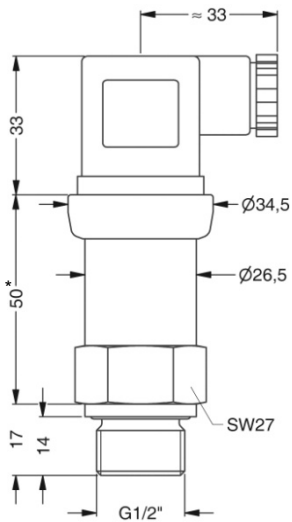

G1/2" DIN 3852  
with ISO 4400

### SIL- and SIL-IS-version

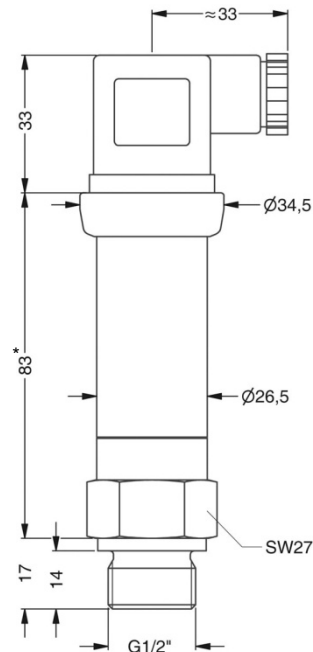

G1/2" DIN 3852  
with ISO 4400

### option

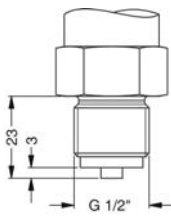

G1/2" EN 837

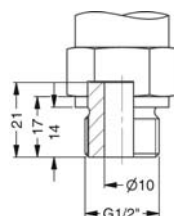

G1/2" DIN 3852 open port,  $P_N \leq 40$  bar

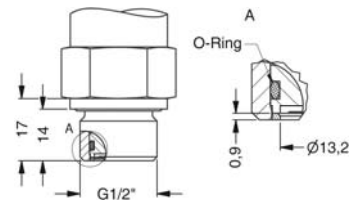

G1/2" DIN 3852  
with flush sensor,  $P_N \leq 40$  bar

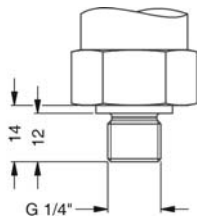

G1/4" DIN 3852

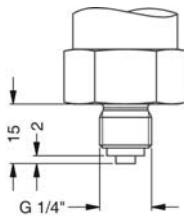

G1/4" EN 837

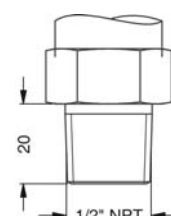

1/2" NPT

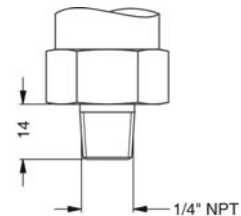

1/4" NPT

⇒ metric threads and other versions on request

\* with electrical connection Bayonet MIL-C-26482 (10-6) increases the length of devices by 5 mm

© 2018 BD|SENSORS GmbH – The specifications given in this document represent the state of engineering at the time of publishing. We reserve the right to make modifications to the specifications and materials.

## Ordering code DMP 331

DMP 331																					
<b>Pressure</b>																					
	gauge	1	1	0																	
	absolute <sup>1</sup>	1	1	1																	
<b>Input</b>																					
	[bar]																				
	0.10 <sup>1</sup>	1	0	0	0																
	0.16 <sup>1</sup>	1	6	0	0																
	0.25 <sup>1</sup>	2	5	0	0																
	0.40	4	0	0	0																
	0.60	6	0	0	0																
	1.0	1	0	0	1																
	1.6	1	6	0	1																
	2.5	2	5	0	1																
	4.0	4	0	0	1																
	6.0	6	0	0	1																
	10	1	0	0	2																
	16	1	6	0	2																
	25	2	5	0	2																
	40	4	0	0	2																
	60	6	0	0	2																
	-1 ... 0	X	1	0	2																
	customer	9	9	9	9															consult	
<b>Output</b>																					
	4 ... 20 mA / 2-wire					1															
	0 ... 20 mA / 3-wire					2															
	0 ... 10 V / 3-wire					3															
	Intrinsic safety 4 ... 20 mA / 2-wire					E															
	SIL2 4 ... 20 mA / 2-wire					1S															
	SIL2 with intrinsic safety 4 ... 20 mA / 2-wire					ES															
	customer					9														consult	
<b>Accuracy</b>																					
	standard for P <sub>N</sub> ≥ 0.4 bar		0.35	%			3														
	standard for P <sub>N</sub> < 0.4 bar						5														
	option 1 for P <sub>N</sub> ≥ 0.4 bar						2														
	option 2			0.1	% <sup>2</sup>		1														
	customer						9													consult	
<b>Electrical connection</b>																					
	Male and female plug ISO 4400						1	0	0												
	Male plug Binder series 723 (5-pin)						2	0	0												
	Cable outlet with PVC cable <sup>3</sup>						T	A	0												
	Cable outlet <sup>4</sup>						T	R	0												
	Male plug M12x1 (4-pin) / metal						M	1	0												
	Bayonet MIL-C-26482 (10-6); 2 wire						B	G	0												
	Bayonet MIL-C-26482 (10-6); 3 wire						B	G	4												
	Compact field housing stainless steel 1.4305						8	5	0												
	customer						9	9	9											consult	
<b>Mechanical connection</b>																					
	G1/2" DIN 3852						1	0	0												
	G1/2" EN 837						2	0	0												
	G1/4" DIN 3852						3	0	0												
	G1/4" EN 837						4	0	0												
	G1/2" DIN 3852 with flush sensor <sup>5</sup>						F	0	0												
	G1/2" DIN 3852 open pressure port <sup>5</sup>						H	0	0												
	1/2" NPT						N	0	0												
	1/4" NPT						N	4	0												
	customer						9	9	9											consult	
<b>Seals</b>																					
	FKM																				1
	EPDM																				3
	without (welded version) <sup>5,6</sup>																				2
	customer																				9
<b>Special version</b>																					
	standard																				0 0 0
	customer																				9 9 9

<sup>1</sup> absolute pressure possible from 0.4 bar  
<sup>2</sup> not in combination with SIL  
<sup>3</sup> standard: 2 m PVC cable without ventilation tube (permissible temperature: -5 ... 70°C), others on request  
<sup>4</sup> cable with ventilation tube (code TR0 = PVC cable), different cable types and lengths available, price without cable  
<sup>5</sup> only for P<sub>N</sub> ≤ 40 bar  
<sup>6</sup> welded version only with pressure ports according to EN 837

© 2018 BD|SENSORS GmbH - The specifications given in this document represent the state of engineering at the time of publishing. We reserve the right to make modifications to the specifications and materials.