

# DMP 331P

## Industrial Pressure Transmitter

Process Connections with  
Flush Welded Stainless Steel  
Diaphragm

accuracy according to IEC 60770:  
standard: 0.35 % FSO  
option: 0.25 % FSO



### Nominal pressure

from 0 ... 100 mbar up to 0 ... 40 bar

### Output signals

2-wire: 4 ... 20 mA / 3-wire: 0 ... 10 V  
others on request

### Special characteristics

- ▶ hygienic version
- ▶ diaphragm with low surface roughness
- ▶ CIP / SIP cleaning up to 150 °C
- ▶ vacuum resistant

### Optional versions

- ▶ IS-version  
Ex ia = intrinsically safe  
for gases and dust
- ▶ SIL 2 version  
according to IEC 61508 / IEC 61511
- ▶ diaphragm in  
Hastelloy® or Tantalum
- ▶ cooling element for media  
temperatures up to 300 °C

The pressure transmitter DMP 331P was designed for use in the food / beverage and pharmaceutical industry. The compact design with hygienic versions makes it possible to achieve an outstanding performance in terms of accuracy, temperature behaviour and long term stability.

The modular construction concept allows a combination of various process connections with different filling fluids and a cooling element. Several electrical connections complete the profile of DMP 331P.

### Preferred areas of use are



Food and beverage



Pharmaceutical industry

### Material and test certificates

- ▶ inspection certificate 3.1  
according to EN 10204
- ▶ test report 2.2  
according to EN 10204



TYPE EL - CLASS I  
REVISION 01/12

# DMP 331P

Industrial Pressure Transmitter

Technical Data

Input pressure range <sup>1</sup>									
Nominal pressure gauge	[bar]	-1...0	0.10	0.16	0.25	0.40	0.60	1	1.6
Nominal pressure abs.	[bar]	-	-	-	-	0.40	0.60	1	1.6
Overpressure	[bar]	5	0.5	1	1	2	5	5	10
Burst pressure ≥	[bar]	7.5	1.5	1.5	1.5	3	7.5	7.5	15
Nominal pressure gauge / abs.	[bar]	2.5	4	6	10	16	25	40	
Overpressure	[bar]	10	20	40	40	80	80	105	
Burst pressure ≥	[bar]	15	25	50	50	120	120	210	
Vacuum resistance		P <sub>N</sub> > 1 bar: unlimited vacuum resistance P <sub>N</sub> ≤ 1 bar: on request							
<sup>1</sup> consider the pressure resistance of fitting and clamps									
Output signal / Supply									
Standard		2-wire: 4 ... 20 mA / V <sub>S</sub> = 8 ... 32 V <sub>DC</sub>				SIL-version: V <sub>S</sub> = 14 ... 28 V <sub>DC</sub>			
Option IS-protection		2-wire: 4 ... 20 mA / V <sub>S</sub> = 10 ... 28 V <sub>DC</sub>				SIL-version: V <sub>S</sub> = 14 ... 28 V <sub>DC</sub>			
Options 3-wire		3-wire: 0 ... 20 mA / V <sub>S</sub> = 14 ... 30 V <sub>DC</sub>							
		0 ... 10 V / V <sub>S</sub> = 14 ... 30 V <sub>DC</sub>							
Performance									
Accuracy <sup>2</sup>		standard: nominal pressure < 0.4 bar: ≤ ± 0.5 % FSO nominal pressure ≥ 0.4 bar: ≤ ± 0.35 % FSO option: nominal pressure ≥ 0.4 bar: ≤ ± 0.25 % FSO							
Permissible load		current 2-wire: R <sub>max</sub> = [(V <sub>S</sub> - V <sub>S min</sub> ) / 0.02 A] Ω current 3-wire: R <sub>max</sub> = 500 Ω voltage 3-wire: R <sub>min</sub> = 10 kΩ							
Influence effects		supply: 0.05 % FSO / 10 V				load: 0.05 % FSO / kΩ			
Long term stability		≤ ± 0.1 % FSO / year at reference conditions							
Response time		2-wire: < 10 msec				3-wire: ≤ 3 msec			
<sup>2</sup> accuracy according to IEC 60770 – limit point adjustment (non-linearity, hysteresis, repeatability)									
Thermal effects (Offset and Span) <sup>3</sup> / Permissible temperatures									
Nominal pressure P <sub>N</sub>	[bar]	-1 ... 0			< 0.40			≥ 0.40	
Tolerance band	[% FSO]	≤ ± 0.75			≤ ± 1.5			≤ ± 0.75	
in compensated range	[°C]	-20 ... 85			0 ... 50			-20 ... 85	
Permissible temperatures <sup>4</sup>		medium: -40 ... 125 °C for filling fluid silicone oil -10 ... 125 °C for filling fluid food compatible oil electronics / environment: -40 ... 85 °C storage: -40 ... 100 °C							
Permissible temperature medium for cooling element 300°C		filling fluid silicone oil		overpressure: -40 ... 300 °C		vacuum: -40 ... 150 °C <sup>5</sup>		filling fluid food compatible oil	
		filling fluid food compatible oil		overpressure: -10 ... 250 °C		vacuum: -10 ... 150 °C <sup>5</sup>			
<sup>3</sup> an optional cooling element can influence thermal effects for offset and span depending on installation position and filling conditions.									
<sup>4</sup> max. temperature of the medium for nominal pressure gauge > 0 bar: 150 °C for 60 minutes with a max. environmental temperature of 50 °C									
<sup>5</sup> also for P <sub>abs</sub> ≤ 1 bar									
Electrical protection									
Short-circuit protection		permanent							
Reverse polarity protection		no damage, but also no function							
Electromagnetic compatibility		emission and immunity according to EN 61326							
Mechanical stability									
Vibration according to DIN EN 60068-2-6		G 1/2": 20 g RMS (25 ... 2000 Hz)				others: 10 g RMS (25 ... 2000 Hz)			
Shock according to DIN EN 60068-2-27		G 1/2": 500 g / 1 msec				others: 100 g / 1 msec			
Filling fluids									
Standard		silicone oil							
Options		food compatible oil according to 21CFR178.3570 (Mobil SHC Cibus 32; Category Code: H1; NSF Registration No.: 141500) others on request							
Materials									
Pressure port		stainless steel 1.4435 (316 L)						others on request	
Housing		stainless steel 1.4404 (316 L)							
Option compact field housing		stainless steel 1.4305 (303), cable gland brass, nickel plated						others on request	
Seals (media wetted)		standard: FKM (recommended for medium temperatures ≤ 200 °C) option: FFKM (recommended for medium temperatures > 200 °C) Clamp, dairy pipe, Varivent®: without						others on request	
Diaphragm		standard: stainless steel 1.4435 (316 L) option: Hastelloy® C-276 (2.4819)						Tantalum on request	
Media wetted parts		pressure port, seal, diaphragm							

Explosion protection (only for 4 ... 20 mA / 2-wire)	
Approvals DX19-DMP 331P	IBExU 10 ATEX 1068 X / IECEx IBE 12.0027X zone 0: II 1G Ex ia IIC T4 Ga zone 20: II 1D Ex ia IIIC T 85°C Da
Safety technical maximum values	$U_i = 28\text{ V}$ , $I_i = 93\text{ mA}$ , $P_i = 660\text{ mW}$ , $C_i \approx 0\text{ nF}$ , $L_i \approx 0\text{ }\mu\text{H}$ , the supply connections have an inner capacity of max. 27 nF to the housing
Ambient temperature range	in zone 0: -20 ... 60 °C with $p_{\text{atm}}$ 0.8 bar up to 1.1 bar in zone 1 or higher: -20 ... 70 °C
Connecting cables (by factory)	cable capacitance: signal line/shield also signal line/signal line: 160 pF/m cable inductance: signal line/shield also signal line/signal line: 1 $\mu\text{H}/\text{m}$
Miscellaneous	
Option SIL2 version <sup>6</sup>	according to IEC 61508 / IEC 61511
Current consumption	signal output current: max. 25 mA                      signal output voltage: max. 7 mA
Weight	min. 200 g (depending on process connection)
Installation position	any (standard calibration in a vertical position with the pressure port connection down; differing installation position for $P_N \leq 2\text{ bar}$ have to be specified in the order)
Operational life	100 million load cycles
CE-conformity	EMC Directive: 2014/30/EU
ATEX Directive	2014/34/EU

<sup>6</sup> only for 4 ... 20 mA / 2-wire

### Wiring diagrams

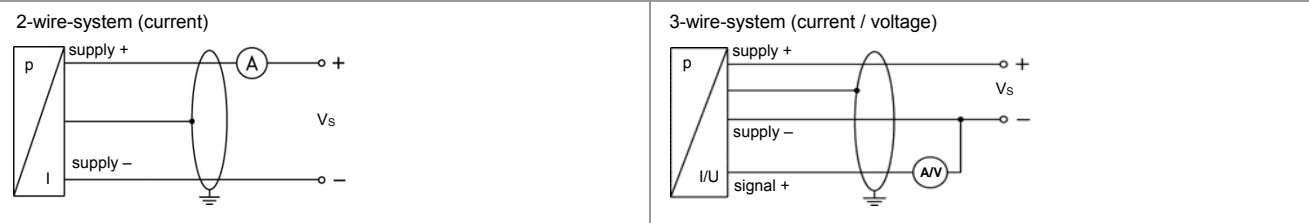

### Pin configuration

Electrical connection	ISO 4400	Binder 723 (5-pin)	M12x1 / metal (4-pin)	field housing	cable colour (IEC 60757)
Supply +	1	3	1	IN +	wh (white)
Supply -	2	4	2	IN -	bn (brown)
Signal + (only 3-wire)	3	1	3	OUT+	gn (green)
Shield	ground pin	5	4	⊥	gn/ye (green-yellow)

### Electrical connections (dimensions in mm)

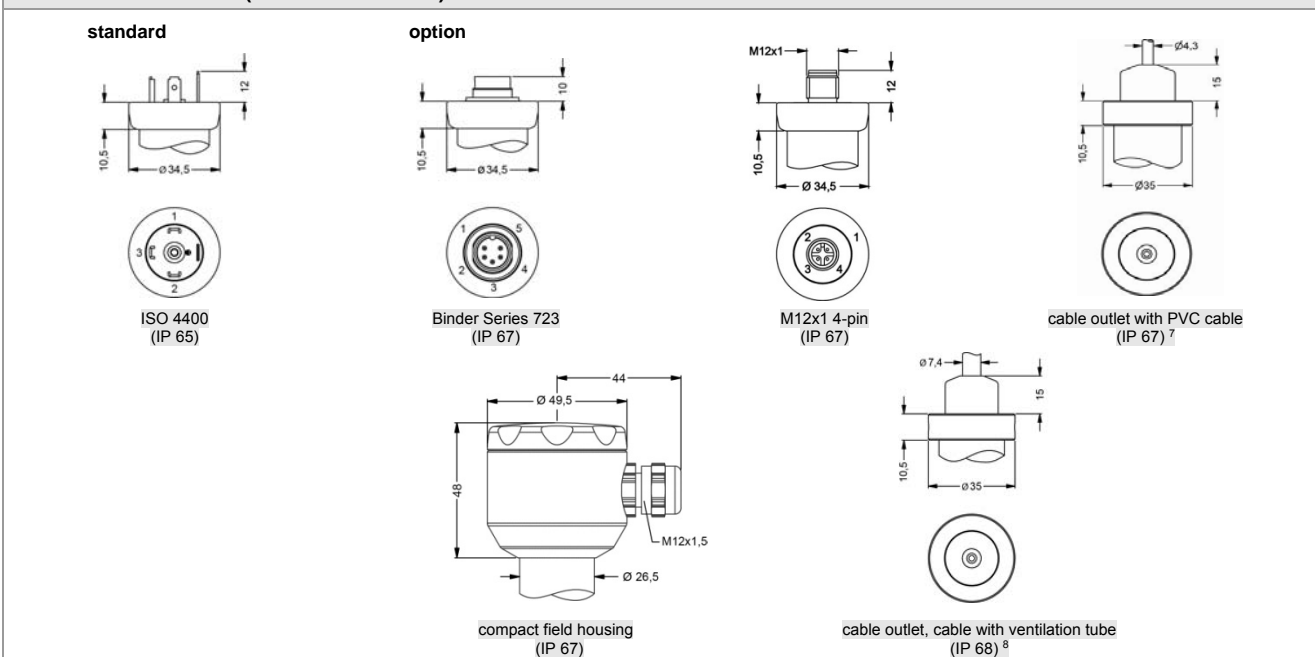

⇒ universal field housing stainless steel 1.4404 (316 L) with cable gland M20x1.5 (ordering code 880) and other versions on request

<sup>7</sup> standard: 2 m PVC cable without ventilation tube (permissible temperature: -5 ... 70°C)

<sup>8</sup> different cable types and lengths available, permissible temperature depends on kind of cable

# DMP 331P

Industrial Pressure Transmitter

Technical Data

## Mechanical connection (dimension in mm)

### Standard

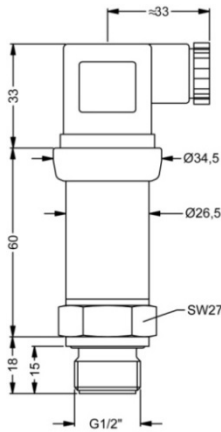

G1/2" flush DIN 3852<sup>9</sup>

### Option

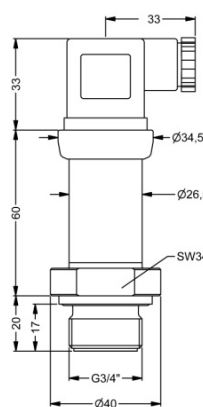

G 3/4" flush DIN 3852 with ISO 4400

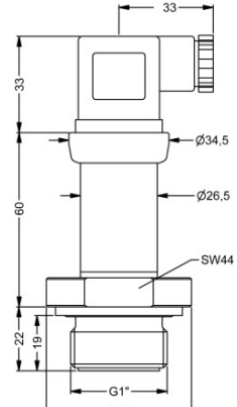

G1" flush DIN 3852 with ISO 4400

### Option

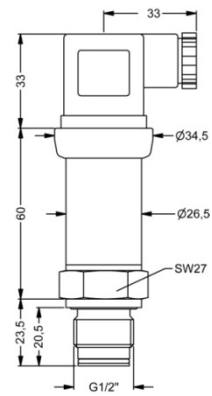

G1/2" flush with radial o-ring<sup>9</sup>

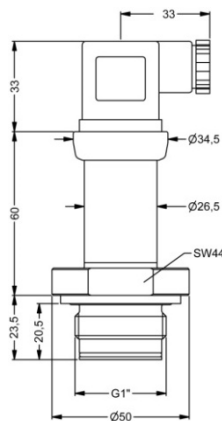

G1" flush with radial o-ring (P<sub>N</sub> ≤ 2 bar)

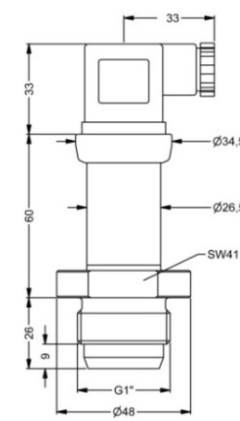

G1" cone with ISO 4400

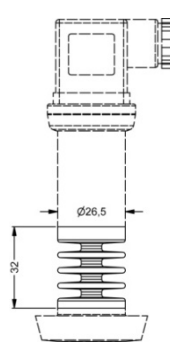

cooling element 300 °C

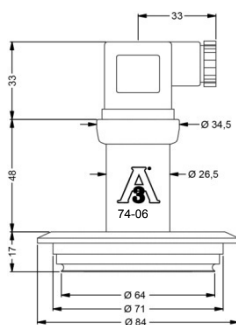

Varivent<sup>®</sup> P<sub>N</sub> ≤ 25 bar

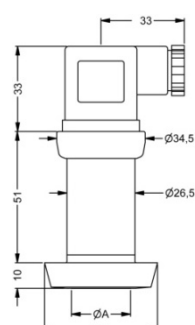

dairy pipe (DIN 11851) with ISO 4400

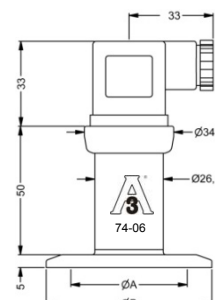

Clamp (DIN 32676) with ISO 4400

dimension in mm				
size	DN 25	DN 40	DN 50	
A	23	32	45	
B	44	56	68.5	
P <sub>N</sub> [bar]	≥ 0.25	≥ 0.25	≥ 0.25	
	≤ 40	≤ 40	≤ 25	

dimension in mm				
size	3/4"	DN 25	DN 32	DN 50
A	14	23	32	45
B	25	50.5	50.5	64
P <sub>N</sub> [bar]	≥ 4	≥ 0.25	≥ 0.25	
	≤ 8	≤ 16	≤ 16	≤ 16

\* higher pressure ranges on request

- ⇒ SIL- and SIL-Ex version: total length increases by 26.5 mm!
- ⇒ metric threads and other versions on request

<sup>9</sup> possible only for P<sub>N</sub> ≥ 1 bar

© 2018 BDI SENSORS GmbH - The specifications given in this document represent the state of engineering at the time of publishing. We reserve the right to make modifications to the specifications and materials.

