

# ***T210P***

## Instruction Manual

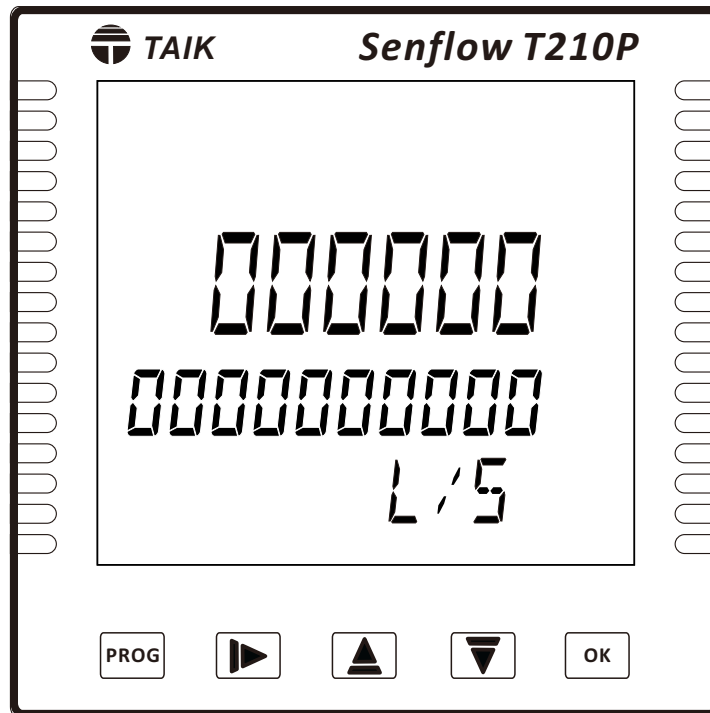

# 1. Hardware Structure :

## 1.1 Push Buttons On Front Panel:

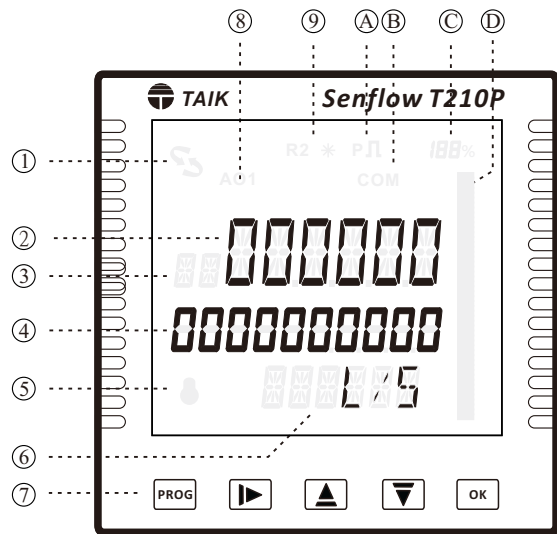

- ① Flow input indication flashes interactive
- ② 6 digits value display
- ③ Parameters display symbol
- ④ Tens digit accumulative value display
- ⑤ Password setting
- ⑥ Unit display
- ⑦ 5 push buttons
- ⑧ If setting first analog output will display
- ⑨ If setting relay contact will display \* : Relay contact activated
- A If setting pulse output will display
- B RS-485 activation
- C Analog output value percentage
- D Analog output value display in bar

## 1.2 Terminals Configuration :

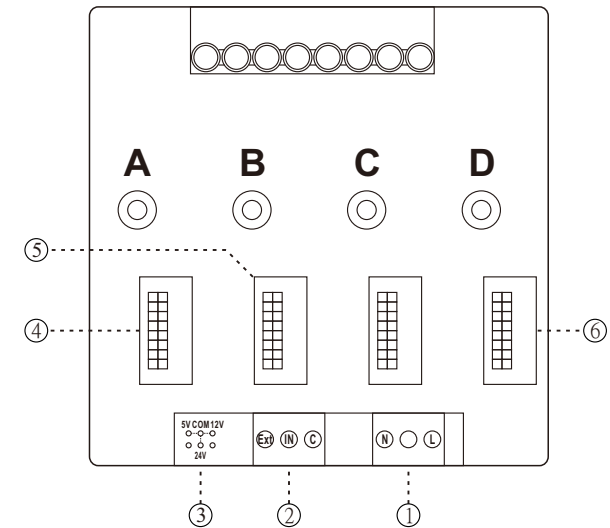

- ① Power supply
- ② Signal input
- ③ Aux. power option
- ④ RS-485 module
- ⑤ AOP1 Analog output module
- ⑥ Pulse and relay contact output module

## 2. Installation/ Wiring :

### 2.1 Case Dimension and Panel Cut-out : Unit : mm

- Rear view

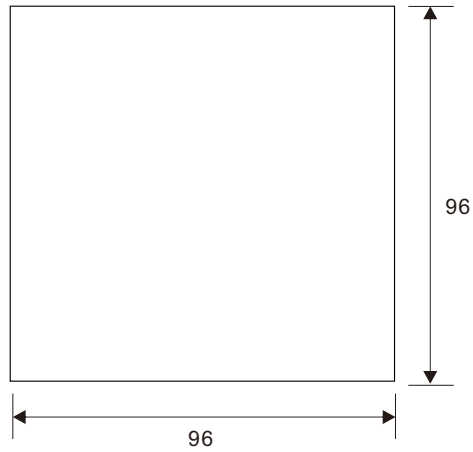

- Side view

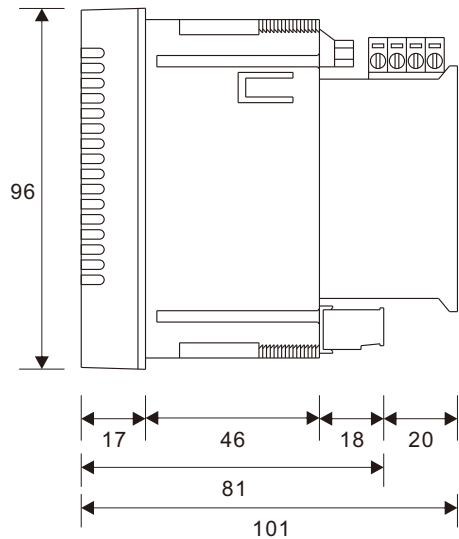

- Cut-out size

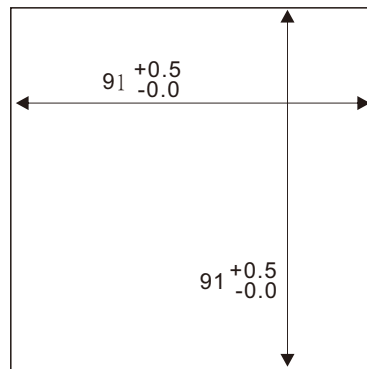

### 2.2 Connection Diagrams

- Meter connection

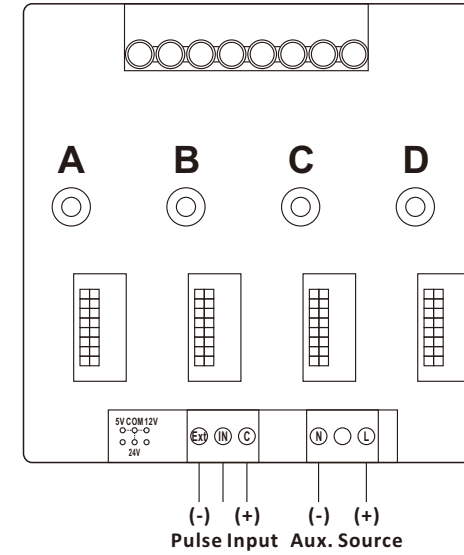

- Module

#### RS - 485

#### MD01

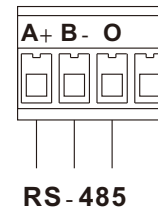

#### Pulse and relay contact

#### MD06

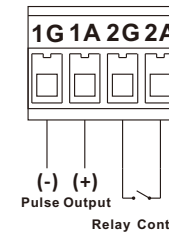

#### Analog output



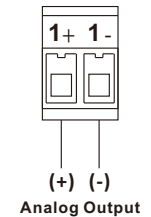

#### MD07

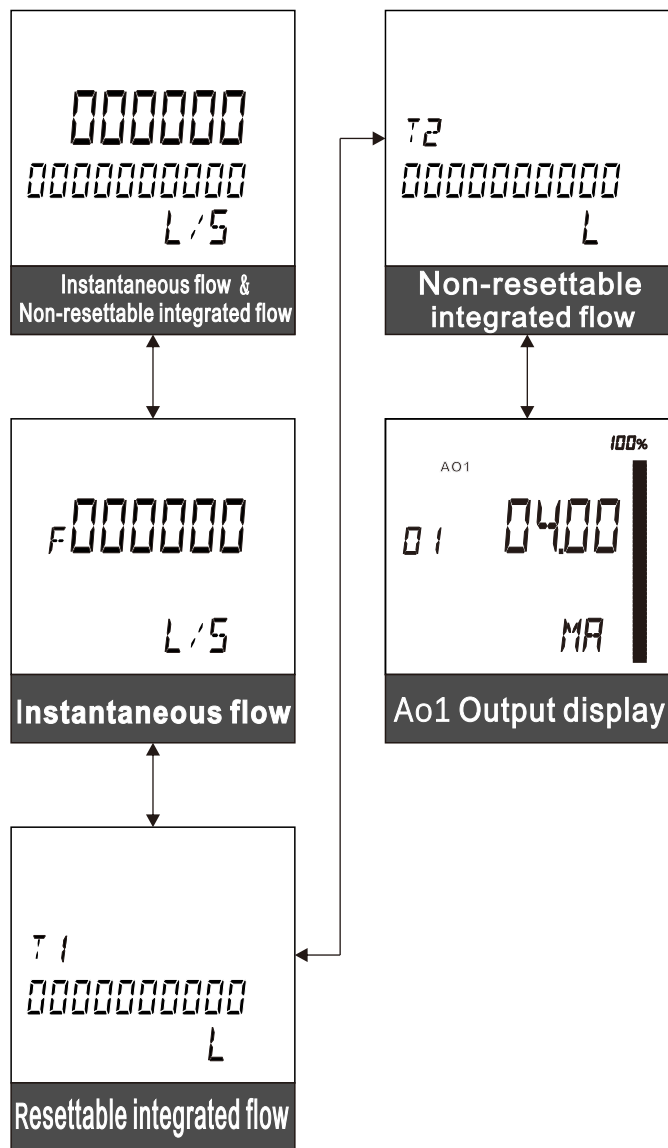

## T210P Display Mode :



### ● Keys Operation :

-  Advanced to the previous display
-  Advanced to the next display
-  Access to the set-up page and enter password
-  Clear integrated values at T1
-  Hold down to relieve error code

### 3.2 Formula Calculation

Instantaneous flow calculation :  $Q = F / K$   
Q : Flow(Ltr./Sec)  
F : Pulse frequency(Hz)  
K : K-factor

Mass flow rate calculation :  $W = Q * DS$   
W : Mass flow rate(kg/s)  
Q : Volume flow rate( $m^3/s$ )  
DS : Density of fluid ( $kg / m^3$ )

### 3.3 Unit Conversion

1L = 1000mL = 0.001 $m^3$  = 0.2642GAL

1kg = 2.205Lb = 0.001TON

1day = 24hour = 1440min = 86400s

### 3.4 Error Code

ERR1 OVERFD : Instantaneous flow exceed set value

ERR2 OVER P : Pulse output exceed available output range

ERR4 AO1ERR : AOP1 output exceed 20mA

ERR6 K-0 : K-factor is zero

ERR7 ROMERR : EEPROM malfunction

ERR10 NOINIT : Ex-factory without calibration

\*\*After error exclusion, hold down  can back to display

## 4. Set-up Page Flowchart :

### 4.1 Menu Flowchart

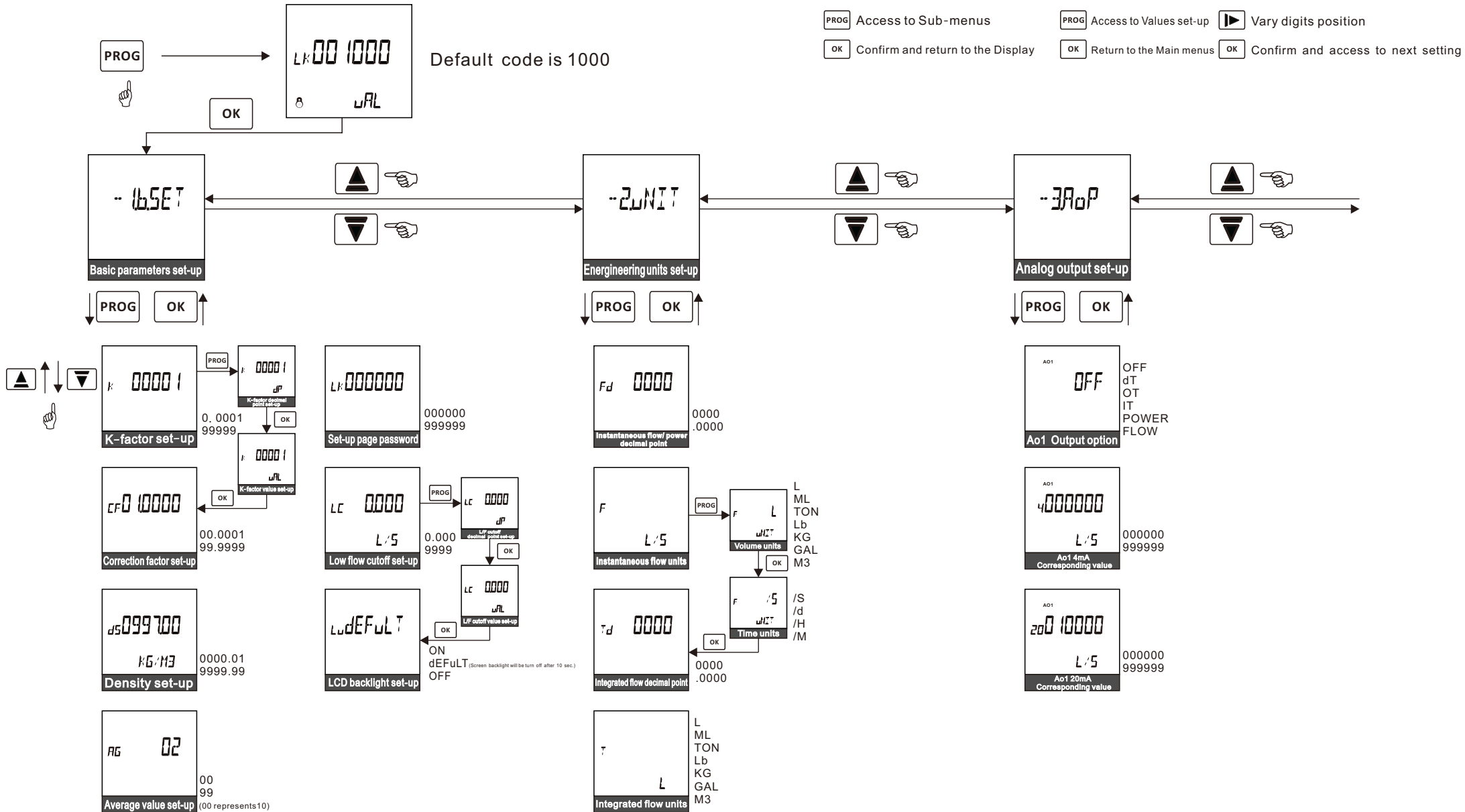

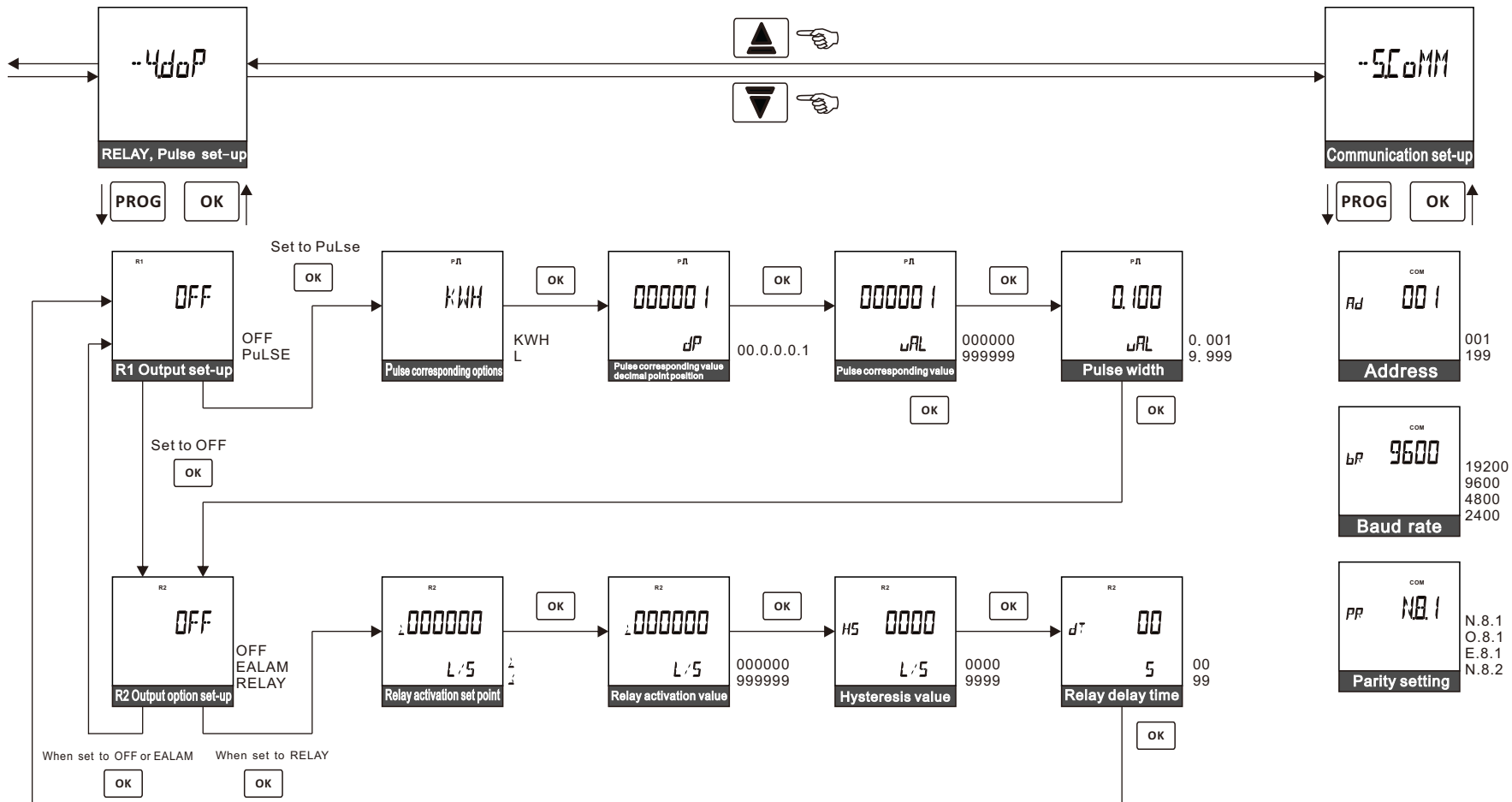

## 4.2 Menu Legends:

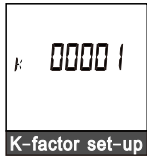

Setting K-factor  
Range: 0.0001~99999

K-factor set-up



Correction factor set-up : A coefficient can correct deviation  
Range: 00.001~99.999

Correction factor set-up

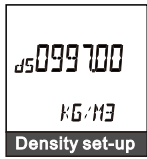

When calculating fluid weight need to set-up liquid density  
Range: 0000.01~9999.99

Density set-up

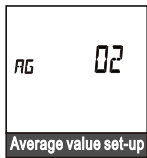

Set-up for average sampling times  
Range: 00~99  
(00 means 10 times)

Average value set-up



Change password  
Range: 000000~999999

Set-up page password

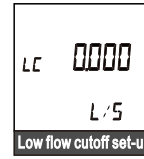

If input is lower than set value will be 0  
Range: 0.000~9999

Low flow cutoff set-up



LCD backlight set-up  
ON : LCD backlight stays on  
dEfuLT : LCD backlight shut down after 10 secs. when not in use  
OFF : Close LCD backlight

Backlight set-up

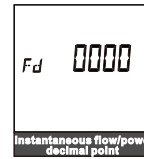

Instantaneous flow/power decimal point position  
Range: .0000~0000°

Instantaneous flow/power decimal point

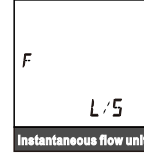

Instantaneous flow units

Volume or weight units : L, ML, TON, Lb, KG, SFT3, NM3  
NL, FT3, GAL, M3

Time units : S : sec., D : day, H : hour, M : month

Instantaneous flow units

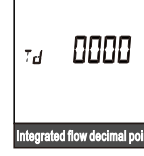

Integrated flow decimal point position  
Range: .0000~0000

Integrated flow decimal point



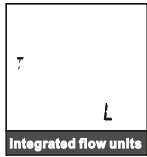

Integrated flow units  
L, ML, TOM, Lb, KG, GAL, M3

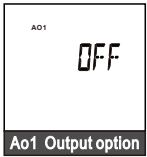

Ao1 output options  
OFF : No output, dT : Temperature differences  
OT : Outflow temperature ,IT : Inflow temperature  
POWER, FLOW

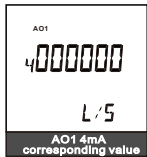

Ao1 4mA corresponding value  
Range: 000000~999999



Ao1 20mA corresponding value  
Range: 000000~999999



Ao2 output options  
OFF : No output, dT : Temperature differences  
OT : Outflow temperature ,IT : Inflow temperature  
POWER, FLOW

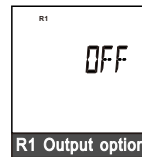

R1 output options  
OFF : output disable, PuLSE : pulse output

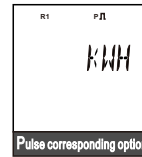

Pulse corresponding options  
KWH : power, L : flow

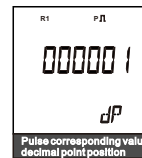

Pulse corresponding value decimal point position  
Range: 000001~00.0001



Setting the accumulative value that corresponding to pulse  
Range: 000000~999999

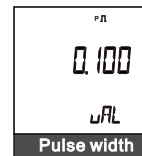

Width of pulse output signal  
0.001~9.999

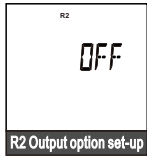

R2 output option  
 OFF : output disable, EALAM : Will activate when error happens  
 RELAY : Set point activation

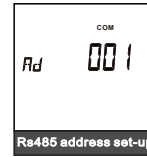

RS-485 communication address set-up  
 Range:001~199



R2 activation set-up point  
 $\geq$  : more than or equal to set value  
 $\leq$  : less than or equal to set value

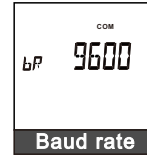

RS-485 baud rate set-up  
 2400,4800,9600,19200



R2 activation set-up point value  
 Range: 000000~999999

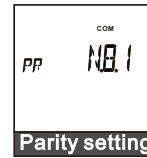

RS-485 parity setting  
 N. 8. 1, O. 8. 1, E. 8. 1, N. 8. 2



Activation set-up point hysteresis setting  
 Range:0000~9999

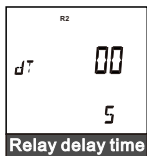

R2 delay time set-up  
 Range:00~99(sec.)

## 5. Specifications:

### 5.1 Specifications

#### ● Display screen :

Format	LCD white backlit
Instantaneous flow digits	5 digits
Integrated flow digits	10 digits
Status symbol	Relay contact status, RS-485 communication status Pulse output, Analog output percentage Input signal status, Unit display, Error message

#### ● Power supply :

Auxiliary power supply	AC/DC85-265V
Frequency Range	45-70Hz
Power consumption	≤15VA(All modules)

#### ● Pulse input:

Input genre	NPN、PNP、open collector
Frequency range	5-10KHz(Default10-10KHz)
Voltage peak-to-peak value	0-30V
Deviation range	±0.05% reading(When over10Hz)

#### ● Communication :

Interface	RS485
Protocol	MODBUS, RTU format
Baud rate	2400~19200 programmable
Address	1~199 programmable
Data format	N,8,1/N,8,2/O,8,1/E,8,1 programmable
Parallel connection	32 meters

#### ● Analog output:

Output range	DC4-20mA isolated
Corresponding value	Instantaneous flow, Instantaneous energy Inflow temperature, Outflow temperature Inflow/Outflow temperature differences
Maximum load	≤350Ω
Deviation range	±0.1%R.O.

#### ● Pulse output:

Output genre	Open Collector (O.C.)
Corresponding value	Integrated flow
Setting range	0.001-999999
Pulse width	0.2 sec.
Maximum load	DC30V 30mA

#### ● Relay contacts output:

Output genre	A contact (N.O.)
Corresponding value	Instantaneous flow high/low alarm or error alarm
Setting range	0-999999
Contact load	AC240V 5A DC24V 5A

#### ● Auxiliary power supply

Output voltage	DC5V, DC12V, DC24V(option)
Max. current	30mA

#### ● Permissible module quantity : At most 3 sets

Rs485 module quantity	1 set(A)
DC analog output module	1 set(B)
Pulse and relay contacts module	1 set(D)

● Application environment :

Operating temperature.....	0-60°C
Operating humidity.....	5-95%RH,non condensing
Storage temperature.....	-10-70°C

● Characteristic and terms:

Sampling time.....	0.3 secs.
Ingress protection.....	Ip54 front,IP20 rear
Dielectric strength.....	Input/Output/Power AC2KV,1min Terminals/Case AC3KV,1min
Surge immunity.....	Input/Output/Power/Case DC500V ≥100MΩ

EMC Testing

Conducted emission.....	EN 55011
Radiated emission.....	EN 55011
Harmonic current emissions.....	EN 61000-3-2
Voltage changes, voltage fluctuations, and flicker.....	En 61000-3-3
Electrostatic discharge.....	IEC61000-4-2
Electromagnrtic field immunity.....	IEC61000-4-3
Electrical fast transient/burst immunity.....	IEC61000-4-4
Surge immunity.....	IEC61000-4-5
immunity to conducted disturbances.....	IEC61000-4-6
Power frequency magnetic field immunity.....	IEC61000-4-8
Short interruptions and voltage variations immunity.....	IEC61000-4-11
CE certification	

## 6. Communications:

### 6.1 Communication protocol :

Adopting MODBUS communication shall use a repeater as the meters are in parallel connection more than 30 pcs.

### 6.2 Transmission mode :

RTU MODE

### 6.3 Communication method :

Rs485 (Half-Duplex)

### 6.4 MODBUS Frame :

#### 6.4.1 Basic Comm and Framing: Hexadecimal Code

Start of frame	Address Field	Function Code	Data Field	Error Check	End of Frame
----------------	---------------	---------------	------------	-------------	--------------

Start of frame : The data is not transmitted by a silent period of at least 4 characters

Address field : The valid MODBUS addresses are in the range of 1-255, the address 0 for broadcast command is only valid for Function Code ⇒ 06H

Function code : 03H⇒Read data  
06H⇒Write data

Data field : The start address of a register. Reading N WORDS and Writing N values

Error check : 16bit CRC ◦

End of frame : The data is not transmitted by a silent period of at least 4 characters

#### 6.4.2 Bit Per Byte: Access to sub-menus 485→FrAE to set-up

Start Bit	Data Bit	Parity	Stop	Frame
1	8	None	2	N · 8 · 2
1	8	Odd	1	O · 8 · 1
1	8	Even	1	E · 8 · 1
1	8	None	1	N · 8 · 1

### 6.5 Reading Register Command :

Query :

Start of Frame	Address Field	Function Code	Start Address Hi	Start Address Lo	Number of Word Hi	Number of Word Lo	Error Check	End of Frame
	01H~FFH	03H	0~nnH	0 ~ nnH	0H	1~nnH	CRC Lo   CRC Hi	
	1 Byte	1 Byte	2Byte		2 Byte		2 Byte	

Response : (Command is correct)

Start of Frame	Address Field	Function Code	Number of Data Byte Count	D0 · D1.. Dn (Hi,Lo,Hi,Lo....)	Error Check	End of Frame
	01H~FFH	03H			CRC Lo   CRC Hi	
	1 Byte	1 Byte	1Byte		2 Byte	

### 6.6 Writing Register Command: A single writing WORD command

Query :

Start of Frame	Address Field	Function Code	Start Address Hi	Start Address Lo	Value Hi..	Value ..Lo	Error Check	End of Frame
	01H~FFH	06H	0~nnH	0 ~ nnH	Setting Value		CRC Lo   CRC Hi	
	1 Byte	1 Byte	2Byte		2 or 4 Byte		2 Byte	

Response : (Response to the writing data if the command is correct)

Start of Frame	Address Field	Function Code	Start Address Hi	Start Address Lo	Value Hi..	Value ..Lo	Error Check	End of Frame
	01H~FFH	06H	0~nnH	0 ~ nnH	Setting Value		CRC Lo   CRC Hi	
	1 Byte	1 Byte	2Byte		2 or 4 Byte		2 Byte	

### 6.7 Message Error : (A command is error)

Start of Frame	Address Field	Function Code	Error Code	Error Check	End of Frame
	01H~FFH	83H or 86H		CRC Lo   CRC Hi	
	1 Byte	1 Byte	1 Byte	2 Byte	

- Function Code : Response to the received Function Code but MSB is set to 1, it functions like 03H ⇒ 83H
- Error Code :
  - 01 : Error Function ◦
  - 02 : Error Data Address ◦
  - 03 : Error Data Value ◦

## 6.8 The CRC Calculation :

The CRC is calculated on all byte of a message from the Address Filed to the last data byte ended (Data Field); Furthermore, it means that the data received is in error if the CRC calculation performed on host does not match the received data.

The CRC Calculation Performed:

1. Load a CRC register with 0 x FFFF
- 2 Exclusive- OR the first 8 bits of the message with the low-order byte of the CRC register. Put the result in the CRC register.
- 3.Shift the CRC register one bit to the right then fill the message in high-order of the CRC register with a zero, and compare the bit shifted out (SLSB).
4. Repeat step 3 if the SLSB=0; Exclusive- OR the CRC register with the value A001(Hex), then put the result in the CRC register if the SLSB=1.
5. Repeat steps 3 and 4 until the 8 bits have been performed and tested.
6. Repeat steps 2 to 5 until all bytes have been performed.
7. Swap a message with low and high order bytes of the CRC register.

CRC Checkup Routine :

The CRC register returned is as unsigned short int.

The starting address and the field of the data are transmitted, and the high and low order bytes of the returned CRC register have been swapped.

```
/*CRC Generation Function with 'C' language*/
/* Msg:*message to calculate CRC upon*/
/* usDatalen: number of bytes in message*/
unsigned int CRC16(char *Msg,unsigned char usDatalen)
{
    unsigned char uchCRCHi=0xFF; /*CRC high byte*/
    unsigned char uchCRCLo=0xFF; /*CRC low byte*/
    unsigned char uIndex;
    while(usDatalen--)/ *pass through message buffer*/
    {
        uIndex=uchCRCHi^*Msg++; /*calculate the CRC*/
        uchCRCHi=uchCRCLo^auchCRCHi[uIndex];
        uchCRCLo=auchCRCLo[uIndex];
    }
}
return (uchCRCHi<<8|uchCRCLo);
```

```
static unsigned char auchCRCHi[]={
0x00,0xc1,0x81,0x40,0x01,0xc0,0x80,0x41,0x01,0xc0,
0x80,0x41,0x00,0xc1,0x81,0x40,0x01,0xc0,0x80,0x41,
0x00,0xc1,0x81,0x40,0x00,0xc1,0x81,0x40,0x01,0xc0,
0x80,0x41,0x01,0xc0,0x80,0x41,0x00,0xc1,0x81,0x40,
0x00,0xc1,0x81,0x40,0x01,0xc0,0x80,0x41,0x00,0xc1,
0x81,0x40,0x01,0xc0,0x80,0x41,0x01,0xc0,0x80,0x41,
0x00,0xc1,0x81,0x40,0x01,0xc0,0x80,0x41,0x00,0xc1,
0x81,0x40,0x00,0xc1,0x81,0x40,0x01,0xc0,0x80,0x41,
0x00,0xc1,0x81,0x40,0x01,0xc0,0x80,0x41,0x01,0xc0,
0x80,0x41,0x00,0xc1,0x81,0x40,0x00,0xc1,0x81,0x40,
0x01,0xc0,0x80,0x41,0x01,0xc0,0x80,0x41,0x00,0xc1,
0x81,0x40,0x01,0xc0,0x80,0x41,0x00,0xc1,0x81,0x40,
0x00,0xc1,0x81,0x40,0x01,0xc0,0x80,0x41,0x01,0xc0,
0x80,0x41,0x00,0xc1,0x81,0x40,0x00,0xc1,0x81,0x40,
0x01,0xc0,0x80,0x41,0x00,0xc1,0x81,0x40,0x01,0xc0,
0x80,0x41,0x01,0xc0,0x80,0x41,0x00,0xc1,0x81,0x40,
0x00,0xc1,0x81,0x40,0x01,0xc0,0x80,0x41,0x01,0xc0,
0x80,0x41,0x00,0xc1,0x81,0x40,0x01,0xc0,0x80,0x41,
0x01,0xc0,0x80,0x41,0x00,0xc1,0x81,0x40,0x01,0xc0,
0x80,0x41,0x00,0xc1,0x81,0x40,0x00,0xc1,0x81,0x40,
0x01,0xc0,0x80,0x41,0x01,0xc0,0x80,0x41,0x00,0xc1,
0x81,0x40,0x00,0xc1,0x81,0x40,0x01,0xc0,0x80,0x41,
0x00,0xc1,0x81,0x40,0x01,0xc0,0x80,0x41,0x01,0xc0,
0x80,0x41,0x00,0xc1,0x81,0x40};
```

```
static unsigned char auchCRCLo[]={
0x00,0xc0,0xc1,0x01,0xc3,0x03,0x02,0xc2,0xc6,0x06,
0x07,0xc7,0x05,0xc5,0xc4,0x04,0xcc,0xc0,0x0d,0xcd,
0x0f,0xcf,0xce,0x0e,0x0a,0xca,0xcb,0x0b,0xc9,0x09,
0x08,0xc8,0xd8,0x18,0x19,0xd9,0x1b,0xdb,0xda,0x1a,
0x1e,0xde,0xdf,0x1f,0xdd,0x1d,0x1c,0xdc,0x14,0xd4,
0xd5,0x15,0xd7,0x17,0x16,0xd6,0xd2,0x12,0x13,0xd3,
0x11,0xd1,0xd0,0x10,0xf0,0x30,0x31,0xf1,0x33,0xf3,
0xf2,0x32,0x36,0xf6,0xf7,0x37,0xf5,0x35,0x34,0xf4,
0x3c,0xfc,0xfd,0x3d,0xff,0x3f,0x3e,0xfe,0xfa,0x3a,
0x3b,0xfb,0x39,0xf9,0xf8,0x38,0x28,0xe8,0xe9,0x29,
0xeb,0x2b,0x2a,0xea,0xee,0x2e,0x2f,0xef,0x2d,0xed,
0xec,0x2c,0xe4,0x24,0x25,0xe5,0x27,0xe7,0xe6,0x26,
0x22,0xe2,0xe3,0x23,0xe1,0x21,0x20,0xe0,0xa0,0x60,
0x61,0xa1,0x63,0xa3,0xa2,0x62,0x66,0xa6,0xa7,0x67,
0xa5,0x65,0x64,0xa4,0x6c,0xac,0xad,0x6d,0xaf,0x6f,
0x6e,0xae,0xaa,0x6a,0x6b,0xab,0x69,0xa9,0xa8,0x68,
0x78,0xb8,0xb9,0x79,0xbb,0x7b,0x7a,0xba,0xbe,0x7e,
0x7f,0xbf,0x7d,0xbd,0xbc,0x7c,0xb4,0x74,0x75,0xb5,
0x77,0xb7,0xb6,0x76,0x72,0xb2,0xb3,0x73,0xb1,0x71,
0x70,0xb0,0x50,0x90,0x91,0x51,0x93,0x53,0x52,0x92,
0x96,0x56,0x57,0x97,0x55,0x95,0x94,0x54,0x9c,0x5c,
0x5d,0x9d,0x5f,0x9f,0x9e,0x5e,0x5a,0x9a,0x9b,0x5b,
0x99,0x59,0x58,0x98,0x88,0x48,0x49,0x89,0x4b,0x8b,
0x8a,0x4a,0x4e,0x8e,0x8f,0x4f,0x8d,0x4d,0x4c,0x8c,
0x44,0x84,0x85,0x45,0x87,0x47,0x46,0x86,0x82,0x42,
0x43,0x83,0x41,0x81,0x80,0x40};
```

## 6.9 Setting Data Address

### 6.9.1 Communication address

Address	(Hex)	Contents	Format	Codename	Access	Range & Unit
0000	0000H	Non-resettable integrated flow	(Note 1)	T2.A	R	0~9999999999
0001	0001H	Non-resettable integrated flow	(Note 1)	T2.B	R	0~9999999999
0002	0002H	Non-resettable integrated flow	(Note 1)	T2.C	R	0~9999999999
0003	0003H	Non-resettable integrated flow	(Note 1)	T2.D	R	0~9999999999
0004	0004H	Resettable integrated flow	(Note 1)	T1.A	R	0~9999999999
0005	0005H	Resettable integrated flow	(Note 1)	T1.B	R	0~9999999999
0006	0006H	Resettable integrated flow	(Note 1)	T1.C	R	0~9999999999
0007	0007H	Resettable integrated flow	(Note 1)	T1.D	R	0~9999999999
0008	0008H	Instantaneous flow/Low byte	Long	FW.L	R	0~99999
0009	0009H	Instantaneous flow/High byte	Long	FW.H	R	0~99999
0010	000AH					
0011	000BH					
0012	000CH					
0013	000DH					
0014	000EH					
0015	000FH					
0016	0010H					
0017	0011H					
0018	0012H					
0019	0013H	K-factor/Low byte	Long	K.L	R/W	1~99999
0020	0014H	K-factor/High byte	Long	K.H	R/W	1~99999
0021	0015H	Correction factor/Low byte	Long	CF.L	R/W	1~999999
0022	0016H	Correction factor/High byte	Long	CF.H	R/W	1~999999
0023	0017H	Density/Low byte	Long	DS.L	R/W	1~999999
0024	0018H	Density/High byte	Long	DS.H	R/W	1~999999
0025	0019H	Average value set-up	Integer	AG	R/W	0~99
0026	001AH	Low flow cutoff	Integer	LC	R/W	0~9999
0027	001BH					
0028	001CH					
0029	001DH	K-factor decimal point	Integer	PDK	R/W	0~4 (Note 2)
0030	001EH	Low flow cutoff decimal point	Integer	LCD	R/W	0~3 (Note 2)
0031	001FH	Define pulse decimal point	Integer	PDP	R/W	0~3 (Note 2)

Address	(Hex)	Contents	Format	Codename	Access	Range & Unit
0032	0020H	Instantaneous flow decimal point	Integer	DPF	R/W	0~3 (Note 2)
0033	0021H	Instantaneous flow units	Integer	UTF	R/W	0~6 (Note 3)
0034	0022H	Instantaneous flow time	Integer	TMF	R/W	0~3 (Note 4)
0035	0023H	Integrated flow decimal point	Integer	DPT	R/W	0~3 (Note 2)
0036	0024H	Integrated flow units	Integer	UTT	R/W	0~6 (Note 3)
0037	0025H					
0038	0026H					
0039	0027H	Ao1 4mA corresponding /Low byte	Long	A1.40.L	R/W	0~999999
0040	0028H	Ao1 4mA corresponding /High byte	Long	A1.40.H	R/W	0~999999
0041	0029H	Ao1 20mA corresponding /Low byte	Long	A1.20.L	R/W	0~999999
0042	002AH	Ao2 4mA corresponding /High byte	Long	A1.20.H	R/W	0~999999
0043	002BH					
0044	002CH					
0045	002DH					
0046	002EH					
0047	002FH					
0048	0030H					
0049	0031H	Relay1 status set-up	Integer	R1V	R/W	0~1 (Note 5)
0050	0032H	Relay2 status set-up	Integer	R2V	R/W	0~2 (Note 6)
0051	0033H	Pulse corresponding value /Low byte	Long	R1_P.L	R/W	0~999999
0052	0034H	Pulse corresponding value /High byte	Long	R1_P.H	R/W	0~999999
0053	0035H	Pulse units	Integer	R1_P.U	R/W	0~1 (Note 7)
0054	0036H	Relay2 alarm value/Low byte	Long	R2_FW.L	R/W	0~999999
0055	0037H	Relay2 alarm value/High byte	Long	R2_FW.H	R/W	0~999999
0056	0038H	Relay2 alarm hysteresis value	Integer	R2_HS	R/W	0~9999
0057	0039H	Relay2 alarm delay	Integer	R2T	R/W	0~99
0058	003AH					
0059	003BH					
0060	003CH					
0061	003DH					
0062	003EH					
0063	003FH					

## 6.9.2 Notes

Address	(Hex)	Contents	Format	Codename	Access	Range & Unit
0064	0040H					
0065	0041H					
0066	0042H					
0067	0043H					
0068	0044H	Zero resettable integrated flow	Integer	RST.T	R/W	1 : Reset
0069	0045H					
0070	0046H	RS-485 address	Integer	ADD	R/W	1~199
0071	0047H	RS-485 baud rate	Integer	BRD	R/W	0~3(Note 8)
0072	0048H	RS-485 parity	Integer	PAR	R/W	0~6(Note 9)

Note	Description
1	Integrated value byte order from high to low is DCBA, if using tens digit calculation, the integrated value: $D * 2^{48} + C * 2^{32} + B * 2^{16} + A$
2	Decimal position : 0 : No decimals , 1 : First decimal place, 2 : Second decimal place 3 : Third decimal places, 4 : Fourth decimal place
3	Flow units : 0 : ml, 1 : L, 2 : m <sup>3</sup> , 3 : Gallon 4 : kg, 5 : lb, 6 : ton
4	Time units : 0 : Sec., 1 : Mins, 2 : Hours, 3 : Days
5	Relay1 status : 0 : Off, 1 : Pulse
6	Relay2 status : 0 : Off, 1 : Alarm set value, 2 : Alarm error
7	Pulse units: 0 : L, 1 : m <sup>3</sup>
8	RS-485 Baud rate : 0 : 2400、1 : 4800、2 : 9600、3 : 19200
9	RS-485 Parity : 0 : n.8.1, 1 : n.8.2, 2 : e.8.1, 3 : o.8.1